

**Silicon NPN Power Transistors**

**2SC2577**

**DESCRIPTION**

- With TO-3PN package
- Complement to type 2SA1102
- High power dissipation
- High current capability

**APPLICATIONS**

- Audio power amplifier
- DC-DC converter

**PINNING**

PIN	DESCRIPTION
1	Base
2	Collector;connected to mounting base
3	Emitter

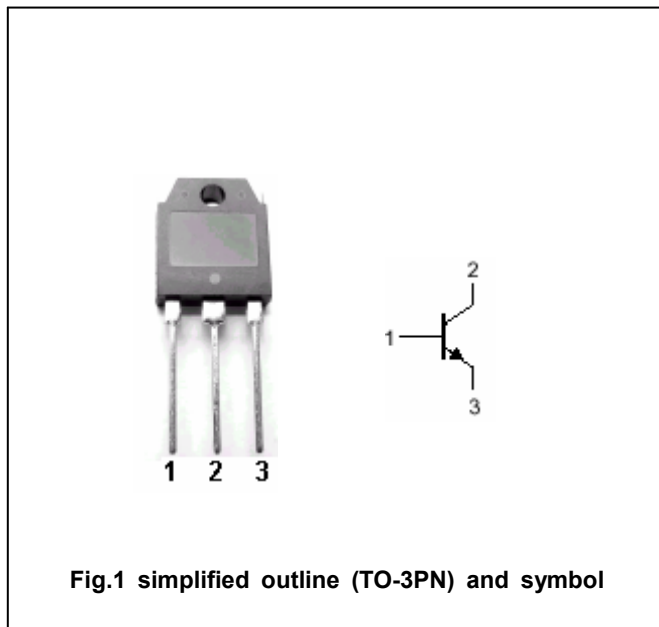

Fig.1 simplified outline (TO-3PN) and symbol

**Absolute maximum ratings(Ta=□)**

SYMBOL	PARAMETER	CONDITIONS	VALUE	UNIT
V <sub>CBO</sub>	Collector-base voltage	Open emitter	120	V
V <sub>CEO</sub>	Collector-emitter voltage	Open base	80	V
V <sub>EBO</sub>	Emitter-base voltage	Open collector	6	V
I <sub>C</sub>	Collector current		6	A
P <sub>C</sub>	Collector power dissipation	T <sub>C</sub> =25□	60	W
T <sub>j</sub>	Junction temperature		150	□
T <sub>stg</sub>	Storage temperature		-55~150	□

## Silicon NPN Power Transistors

## 2SC2577

## CHARACTERISTICS

T<sub>j</sub>=25 °C unless otherwise specified

SYMBOL	PARAMETER	CONDITIONS	MIN	TYP.	MAX	UNIT
V <sub>(BR)CEO</sub>	Collector-emitter breakdown voltage	I <sub>C</sub> =25mA ; I <sub>B</sub> =0	80			V
V <sub>(BR)CBO</sub>	Collector-base breakdown voltage	I <sub>C</sub> =1mA ; I <sub>E</sub> =0	120			V
V <sub>(BR)EBO</sub>	Emitter-base breakdown voltage	I <sub>E</sub> =1mA ; I <sub>C</sub> =0	6			V
V <sub>CEsat</sub>	Collector-emitter saturation voltage	I <sub>C</sub> =3A; I <sub>B</sub> =0.3A			1.5	V
I <sub>CBO</sub>	Collector cut-off current	V <sub>CB</sub> =120V; I <sub>E</sub> =0			100	μA
I <sub>EBO</sub>	Emitter cut-off current	V <sub>EB</sub> =6V; I <sub>C</sub> =0			100	μA
h <sub>FE</sub>	DC current gain	I <sub>C</sub> =2A ; V <sub>CE</sub> =4V	50			
f <sub>T</sub>	Transition frequency	I <sub>C</sub> =0.5A ; V <sub>CE</sub> =10V		20		MHz

Silicon NPN Power Transistors

2SC2577

PACKAGE OUTLINE

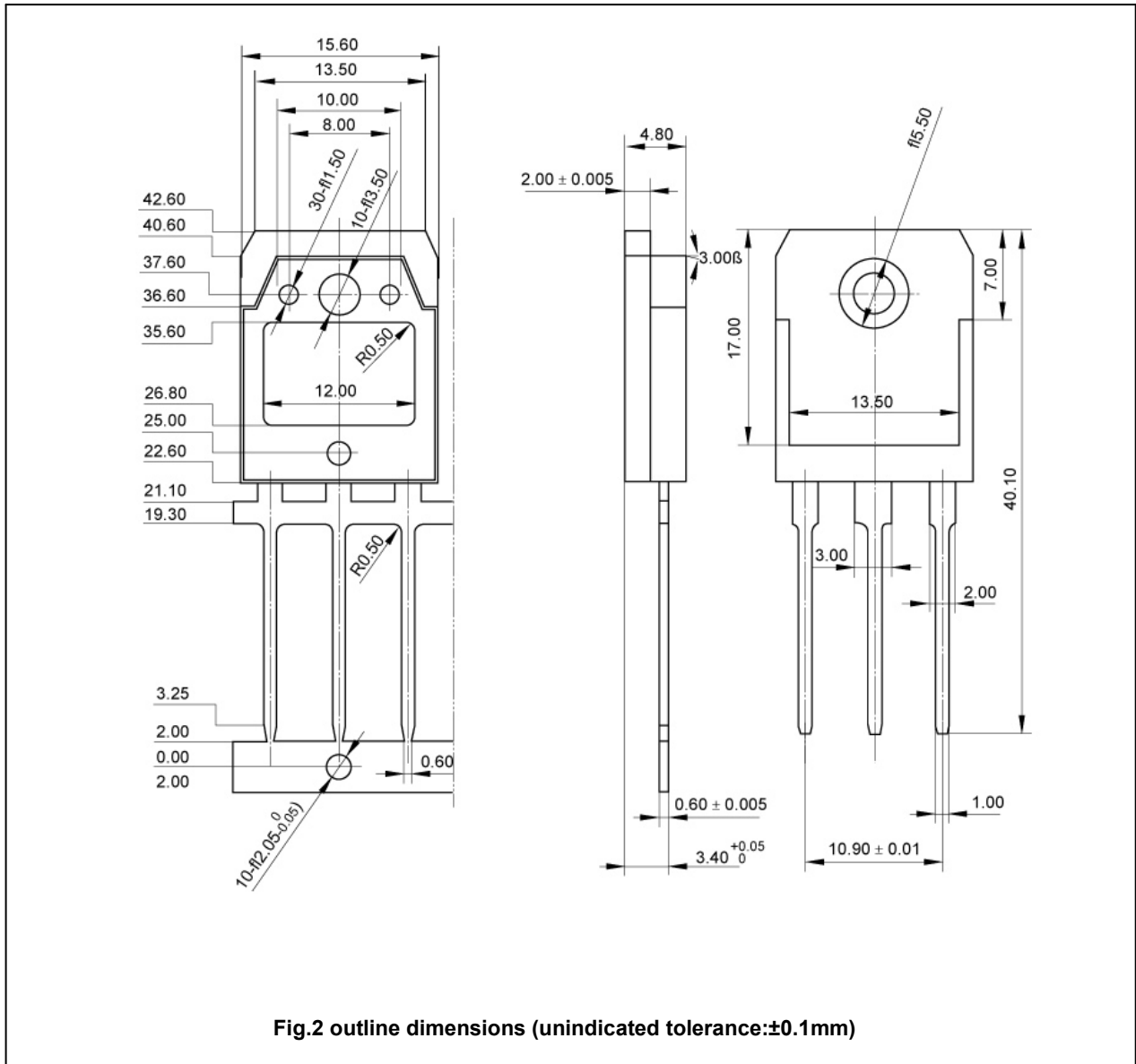

Fig.2 outline dimensions (unindicated tolerance:±0.1mm)